

MINI GATE

WITH SMALL PET DOOR

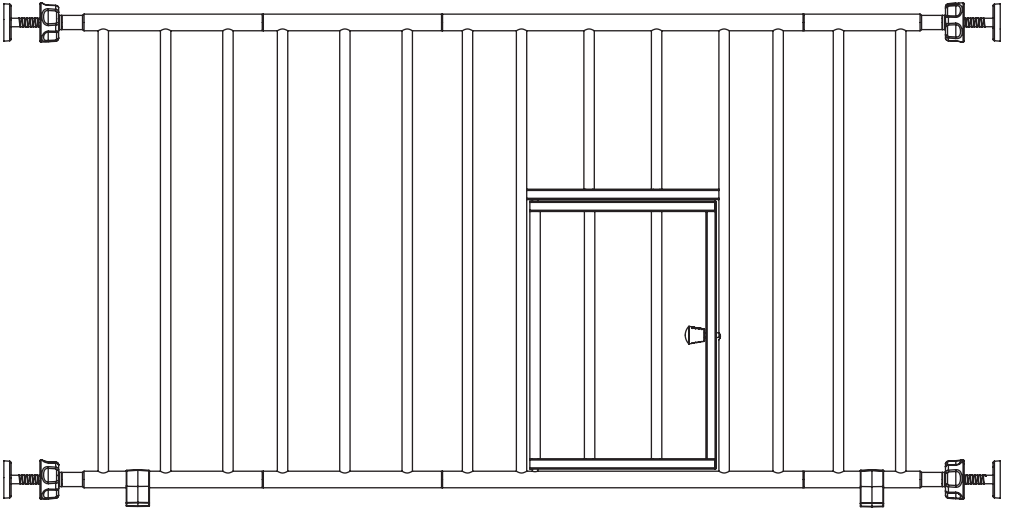

- READ ALL INSTRUCTIONS BEFORE ASSEMBLY AND USE OF GATE.
- KEEP INSTRUCTIONS FOR FUTURE USE.

 www.carlsonpetproducts.com

 Carlson Pet Products, Inc.
3200 Corporate Center Drive, Suite 105 | Burnsville, MN 55306, USA

 952.435.1084

Made in China

Before Using Product

Read and follow all instructions carefully to ensure that your gate and extensions are properly installed. Improper installation could result in the gate becoming unstable or dislodged from the doorway. Please keep these instructions for your reference.

WARNING

- To prevent serious injury or death, securely install gate or enclosure and use according to manufacturer's instructions.
- Check the gate regularly to see if all the hardware and mountings are tightened.
- This is a Pet Gate. NOT intended for use with children.
- This is a Pet Gate, but when used around children the small pet door must remain closed and securely latched.
- Strangulation hazard: pets can force themselves into very small openings; use this gate with pets whose heads will not fit into openings in the gate, between the gate and floor, or between the gate and wall.
- Never use with pet able to climb over or dislodge/open the gate or enclosure.
- Never leave pet unattended.
- This gate is designed to fit openings 29 to 38 inches.

Before Assembly

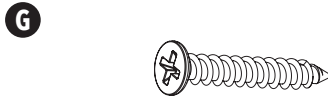
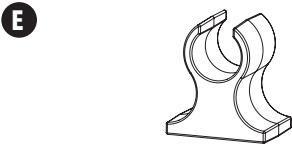
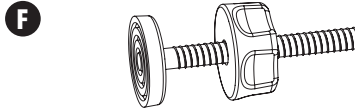
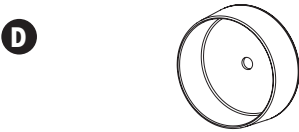
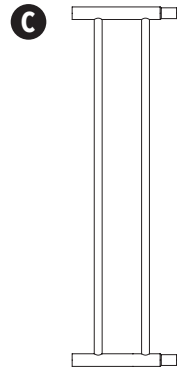
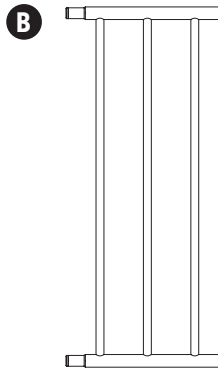
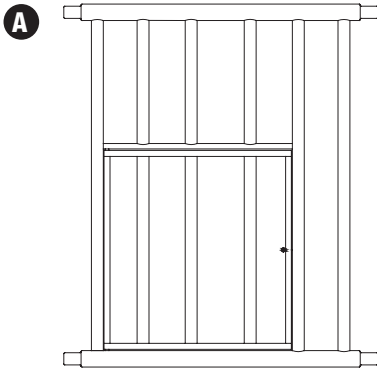

PLEASE CHECK TO MAKE SURE YOU HAVE THE FOLLOWING PARTS:

- A** *Main Gate Frame* (1)
- B** *6" Extensions* (2)
- C** *4" Extension* (1)
- D** *Wall Cups* (4)
- E** *Foot Stands* (2)
- F** *Threaded Spindle Rods w/Adjustment Wheel* (4)
- G** *1" Wall Mount Screws* (4) (requires a Phillips/cross-head screwdriver)

Assembling and Installing Your Gate

STEP 1

Attach all the provided panels together.

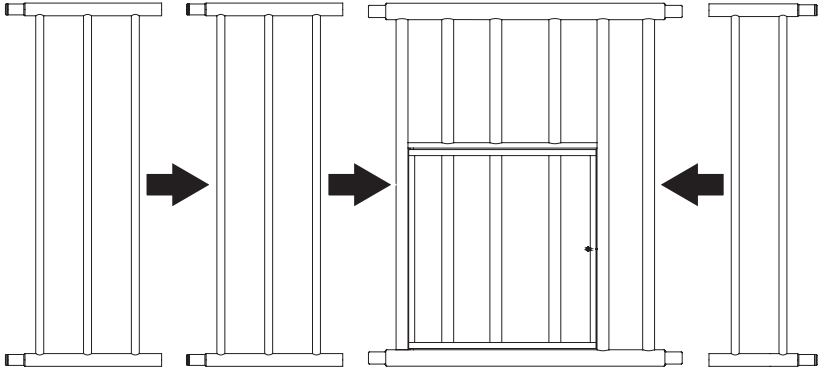

STEP 2

Locate the (4) threaded spindle rods. Rotate the *adjustment wheels* along the threading, eliminating the gap between the *adjustment wheel* and the *rubber foot*.

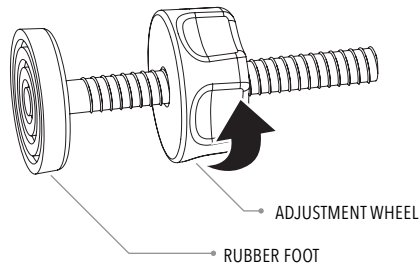

STEP 3

Attach the *foot stands* (2) to the bottom of the gate.

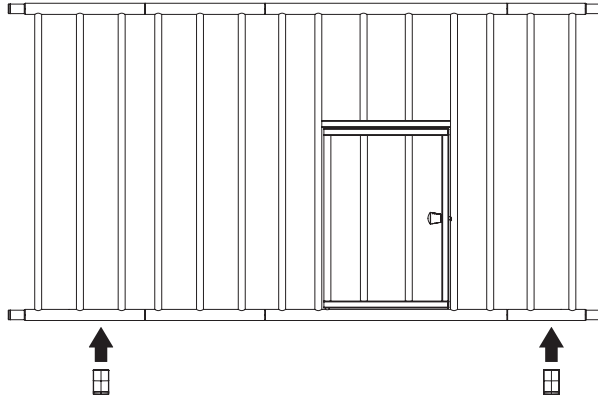

STEP 4

Insert the (4) *threaded spindle rods* into the holes at each of the four corners of the gate. The *adjustment wheel* should touch the end of the frame tube.

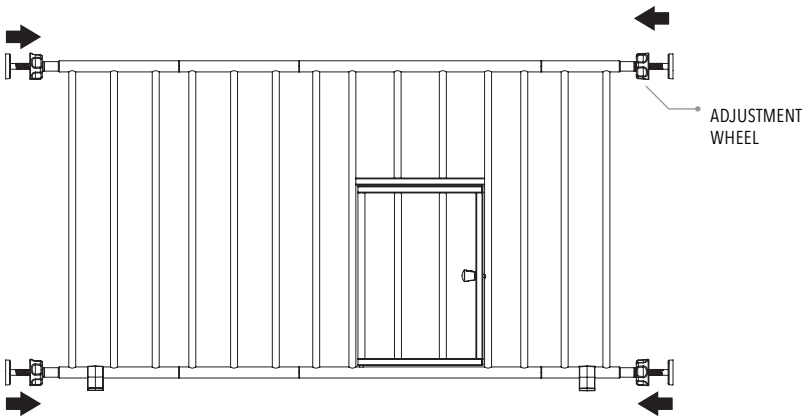

NOTE: The ends of the gate frame are not threaded. The *threaded spindle rods* should slide into the end of the frame tubes without any resistance.

STEP 5

Position the gate so that it is level and centered within your doorway or opening. Rotate the *adjustment wheels* on the *threaded spindle rods* in the opposite direction as in STEP 1, expanding the gap between the *rubber foot* and the *adjustment wheel*.

Expand each of the *threaded spindle rods* until they make contact with the doorway or opening. When you are satisfied with the general placement of your gate, fully tighten the *threaded spindle rods*.

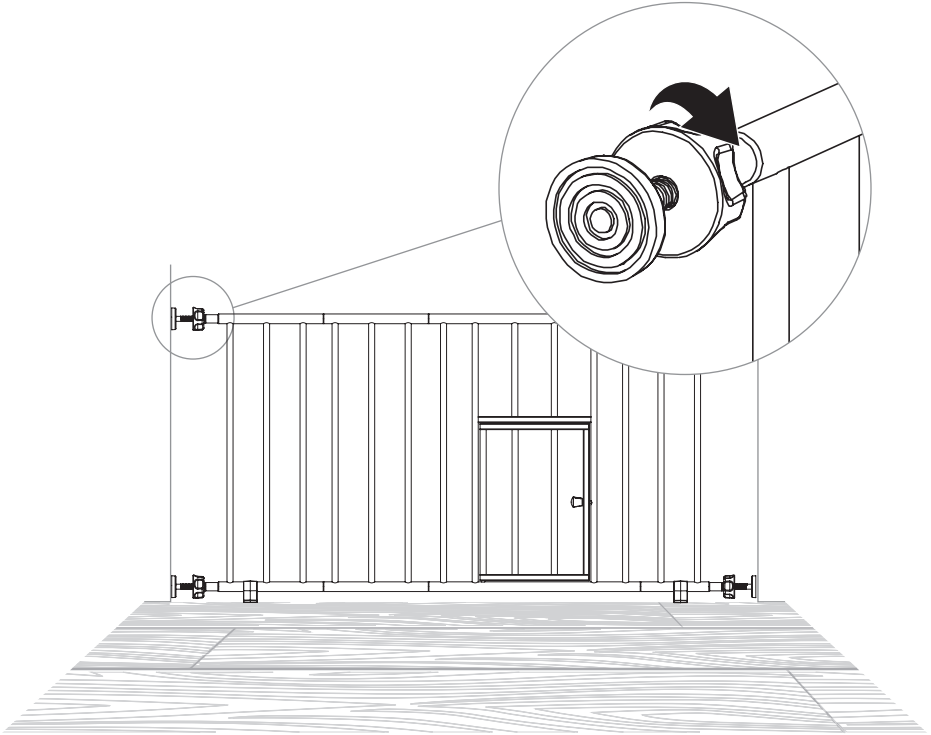

NOTE: It may be necessary to hold the *threaded spindle rods* or *rubber feet* while rotating the *adjustment wheels* to ensure the entire unit does not rotate.

There should be equal spacing among each of the (4) *threaded spindle rods*. Make the appropriate adjustment to ensure you have installed your gate safely.

Positioning and Attaching the Wall Cups

Your gate is a pressure mounted gate. Therefore, it is not necessary to use the screw attached *wall cups* in your door opening if you choose not to. However, **if you are using the gate at the top of the stairs you must use the *wall cups***. Using the *wall cups* will affix your gate more firmly in the doorway or opening.

STEP 1

After you have mounted your gate, and you are satisfied with its positioning, draw a circle on the surface of your doorway or opening around the perimeter of the (4) *rubber feet*.

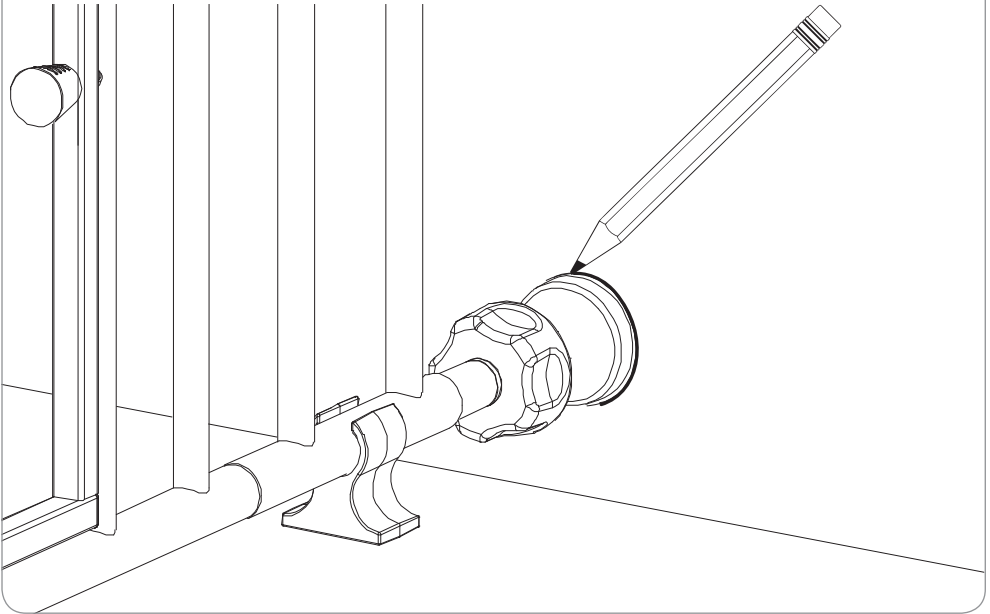

STEP 2

Next, completely remove the gate from the opening by loosening each of the (4) *threaded spindle rods* and depressurizing the gate.

STEP 3

With the gate fully removed, you can now use the circles you marked during STEP 1 as guides for screwing in your (4) *wall cups*.

Center each of the *wall cups* within the guide circles and use the provided *self-tapping screws* to fasten them in place via the hole through the center of each *wall cup*.

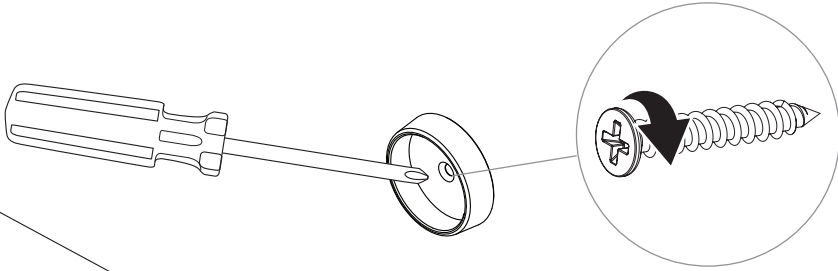

STEP 4

Reinstall your gate in the doorway or opening according to the instructions, using the newly installed *wall cups* as anchoring points for the (4) *threaded spindle rods*.

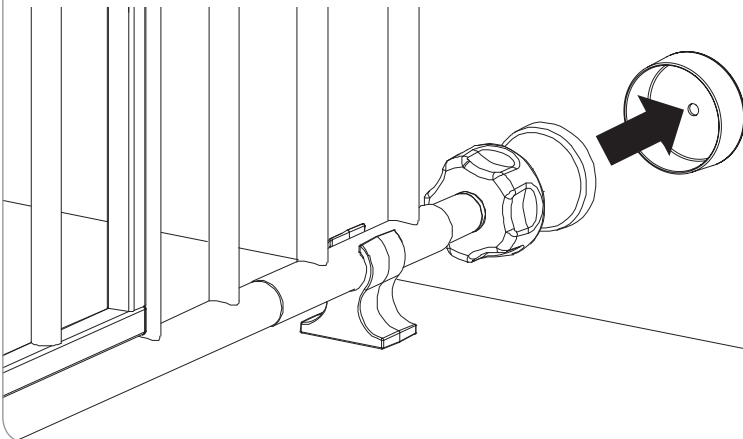

SMALL PET DOOR

To use the small pet door, pull back on the *spring pin*.

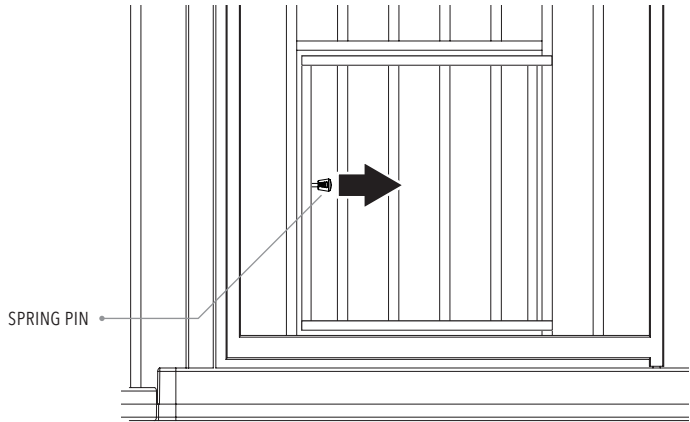

CARE AND MAINTENANCE

Periodically check the gate for signs of damage, wear, or missing components. Do not use if any part is missing, worn or damaged. Check the gate regularly to ensure all the hardware and mountings are tightened. Do not use abrasive cleaners or bleach. Clean by sponging with warm water and a mild detergent.

90 DAYS LIMITED WARRANTY

If, during the first 90 days after consumer purchase of the item, under reasonable and non-commercial use and conditions of maintenance, it fails while owned by the original purchaser because of the quality of materials or workmanship of finish and assembly, Carlson Pet Products, Inc. will replace or repair it at Carlson's option. **PROOF OF PURCHASE REQUIRED.**

Replacement Parts

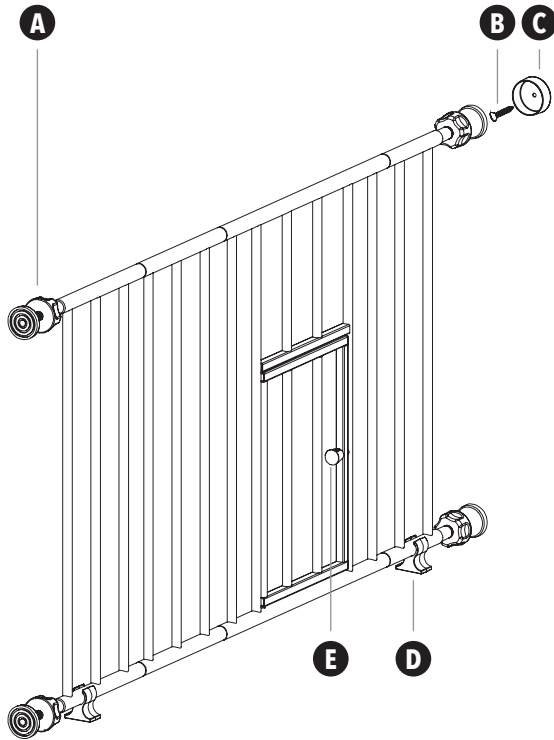

- A** **Threaded Spindle Rods
w/Adjustment Wheel**
Gray = #14016

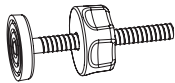

- D** **Foot Stand**
Gray = #14040



- B** **1" Wall Mount Screws**
#10001



- E** **Pet Door Pull Lock**
White = #13038

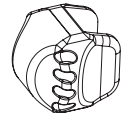

- C** **Wall Cups**
Gray = #14015





www.carlsonpetproducts.com



Carlson Pet Products, Inc.
3200 Corporate Center Drive, Suite 105
Burnsville, MN 55306, USA



952.435.1084